

Data for Biology Test 3-24

Genetics – Std 3, Obj's 2 & 4

A

	B	B
b	Bb	Bb
b	Bb	Bb

B

	R	r
R	RR	Rr
r	Rr	rr

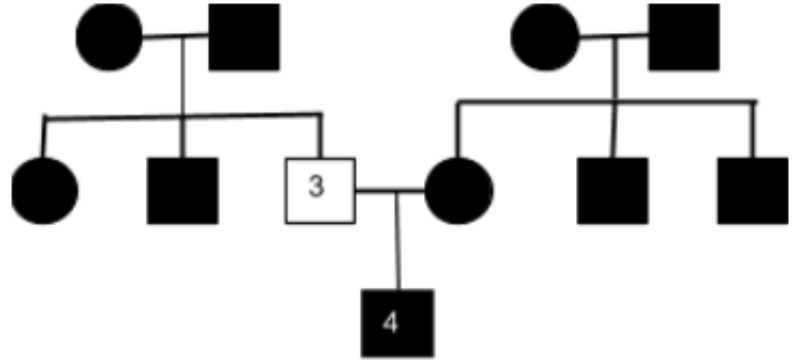



C

	B	T
B	BB	BT
B	BB	BT

D







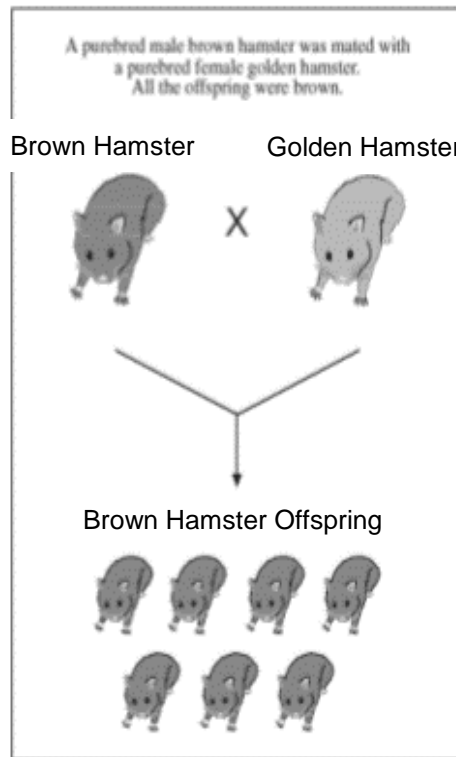

	I ^A	I ^B
I ^B	I ^A I ^B	I ^B I ^B
i	I ^A i	I ^B i

In pea plants, when seeds are formed, the regular allele, R, is dominant over the wrinkled allele, r.

Regular Seed Appearance	Wrinkled Seed Appearance
	

CALICO CAT



		R	r
A	r		
	r		
B		R	r
	r		
C		R	r
	r		
D		R	r
	r	